

THESE DRAWINGS ARE THE PROPERTY OF QUALTEK ELECTRONICS AND NOT TO BE REPRODUCED FOR OR COMMUNICATED TO A THIRD PARTY WITHOUT THE EXPRESS WRITTEN PERMISSION OF AN OFFICER OF QUALTEK ELECTRONICS.

REVISION			
REV.	DESCRIPTION	DATE	APPROVED
B	RoHS Compliancy	06-01-06	DP
C	Updated Specifications	08-28-08	LY

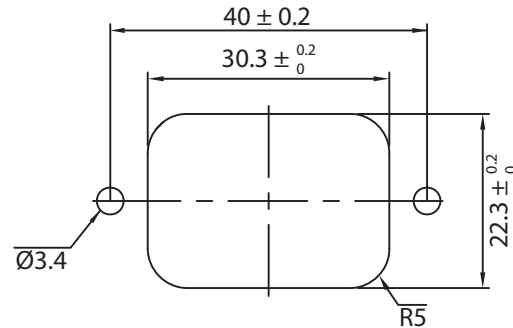

MOUNTING INLET FLANGE AT BACK OF COVER

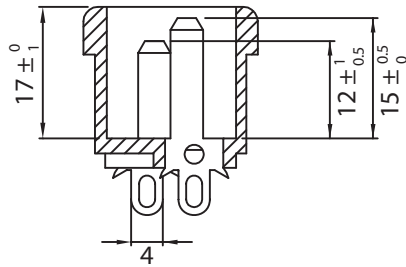
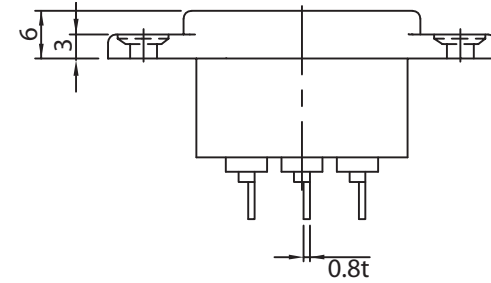
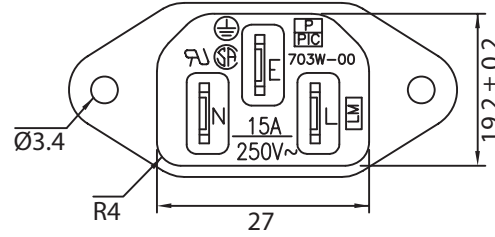
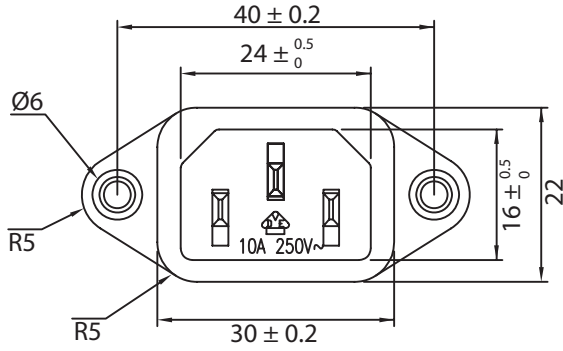
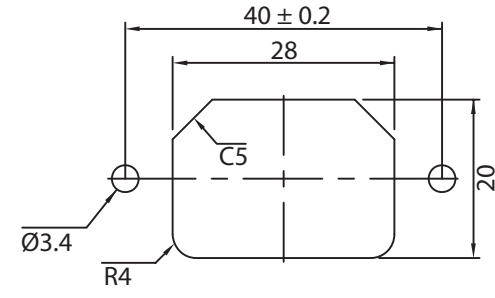

MOUNTING INLET FLANGE IN FRONT OF COVER

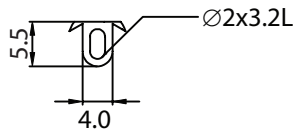

NOTES:

RATING:

UL, CSA: 15A 250V AC
VDE: 10A 250V AC

APPROVALS: UL, CSA, VDE
COUNTERSUNK HOLES
RoHS COMPLIANT

CONTROLLED

Dim range (mm)	Tolerance +/- (mm)	Qualtek Electronics Corp. PPC DIVISION		
		Part Number: 703W-00/06	RoHS Compliant	
0-1	0.15	Description: AC RECEPTACLE		
1-6	0.20			
6-18	0.30	UNIT: mm		REV. C
18-50	0.50	Drawn / Date		Checked / Date
50-120	0.70	B. ZHANG 08-19-04		Approved / Date
120-250	0.90			08-19-04
250-500	1.20			JJH / 08-19-04