

THESE DRAWINGS ARE THE PROPERTY OF QUALTEK ELECTRONICS AND NOT TO BE REPRODUCED FOR OR COMMUNICATED TO A THIRD PARTY WITHOUT THE EXPRESS WRITTEN PERMISSION OF AN OFFICER OF QUALTEK ELECTRONICS.

REVISION			
REV.	DESCRIPTION	DATE	APPROVED
B	RoHS Compliancy	06-01-06	DP
C	Updated Approvals	03-16-15	LY

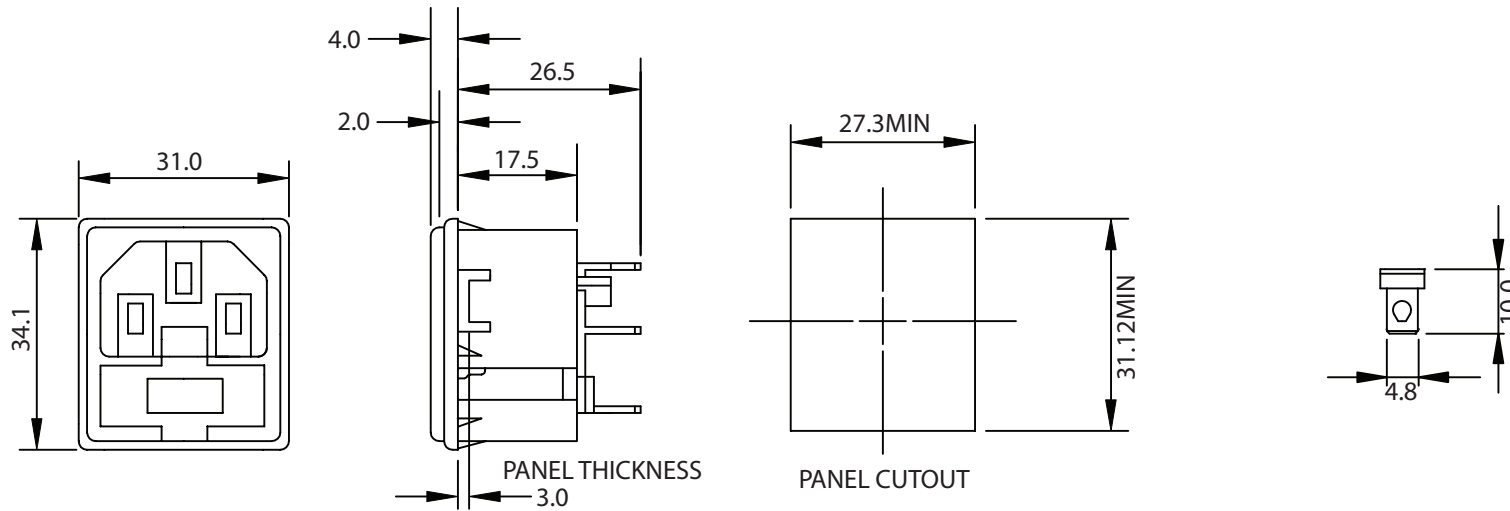

NOTES:

MAX RATING: 10A 250V AC  
 CONTACT RESISTANCE: <10 m OHM 9<15 OHM INCLUDING FUSEHOLDER  
 INSULATION RESISTANCE: >10<sup>3</sup> M OHM  
 A.C. BREAKDOWN: POLE-POLE 5.5kV.  
 POLES-PANEL 4.0kV  
 OPERATING TEMPERATURE: -40 °C TO 70 °C  
 MAX. PIN TEMPERATURE: +65 °C  
 MATERIALS: NYLON, FLAMMABILITY RATING UL 94 V-0  
 CONTACTS: BRASS, PINS NICKEL PLATED, TAGS TIN PLATED

DUAL FUSE HOLDER, ONE ACTIVE, ONE SPARE  
 FUSES NOT INCLUDED - RECOMMENDED SIZE: 5 X 20mm  
 APPROVALS: UL, CSA  
 RoHS COMPLIANT

**CONTROLLED**

Dim range (mm)	Tolerance +/- (mm)	Qualtek Electronics Corp. PPC DIVISION		
		Part Number:	723-30/48	RoHS Compliant
0-1	0.15	Description: SNAP-IN INLET WITH FUSEHOLDER		
1-6	0.20			
6-18	0.30		UNIT: mm	REV. C
18-50	0.50			
50-120	0.70	Drawn / Date	Checked / Date	Approved / Date
120-250	0.90	B.Zhang 08-06-03	08-06-03	JJH / 08-06-03
250-500	1.20			