

THESE DRAWINGS ARE THE PROPERTY OF QUALTEK ELECTRONICS AND NOT TO BE REPRODUCED FOR OR COMMUNICATED TO A THIRD PARTY WITHOUT THE EXPRESS WRITTEN PERMISSION OF AN OFFICER OF QUALTEK ELECTRONICS.

REVISION			
REV.	DESCRIPTION	DATE	APPROVED

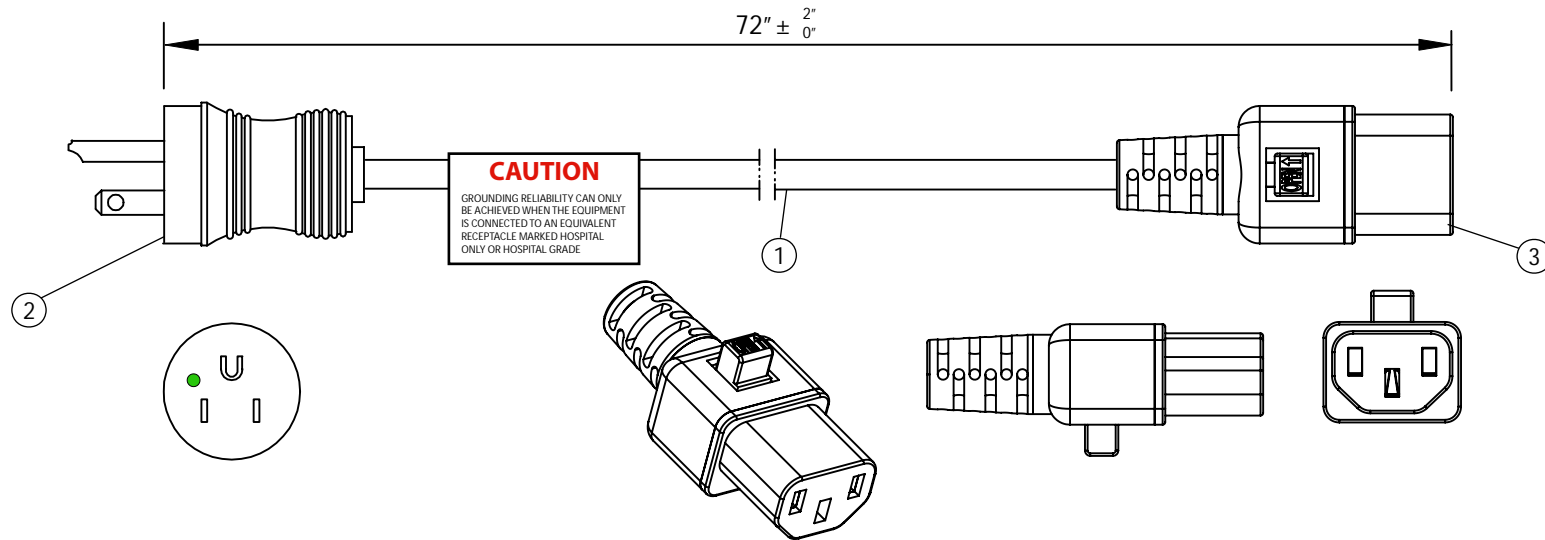

CONTROLLED

NOTES:

1. CORDAGE: SJTW, 16AWG / 3C, UNSHIELDED, NA COLOR CODE, TEMP. RATING: 105°C, RATING: 125V 13A, JACKET COLOR: BLACK
2. PLUG: NEMA 5-15P HOSPITAL GRADE (CLEAR)
3. CONNECTOR: LOCKING IEC 60320 C13 (BLACK)
4. APPROVALS: UL, cUL
5. ROHS COMPLIANT
6. LOCKING CONNECTOR RATED UP TO MAXIMUM 35LBS.
7. CAUTION LABEL

Dim range (mm)	Tolerance +/- (mm)	Qualtek Electronics Corp. PPC DIVISION		
0-1	0.15	Part Number: 533007-01		RoHS Compliant
1-6	0.20	Description: HOSPITAL GRADE LOCKING POWER CORD		
6-18	0.30			
18-50	0.50	UNIT: in		
50-120	0.70	Drawn / Date	Checked / Date	Approved / Date
120-250	0.90	R. Nuti 04-12-24	04-12-24	LY / 04-12-24
250-500	1.20			