

THESE DRAWINGS ARE THE PROPERTY OF QUALTEK ELECTRONICS AND NOT TO BE REPRODUCED FOR OR COMMUNICATED TO A THIRD PARTY WITHOUT THE EXPRESS WRITTEN PERMISSION OF AN OFFICER OF QUALTEK ELECTRONICS.

REVISION			
REV.	DESCRIPTION	DATE	APPROVED

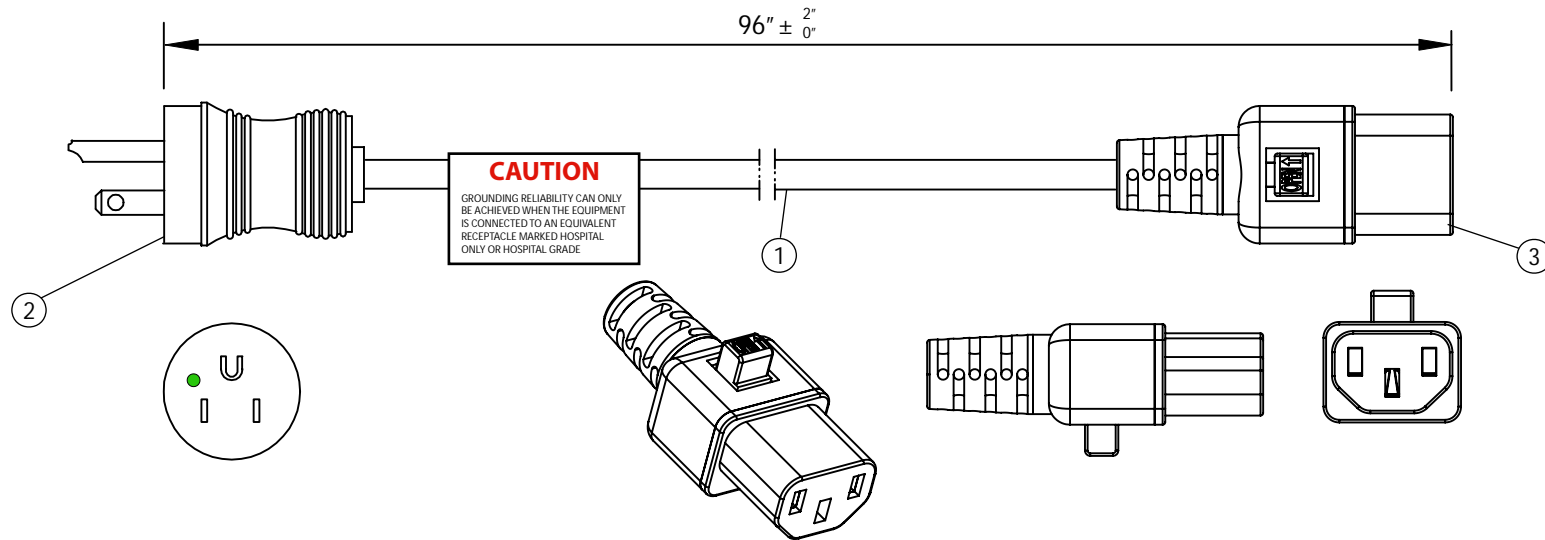

CAUTION
 GROUNDING RELIABILITY CAN ONLY BE ACHIEVED WHEN THE EQUIPMENT IS CONNECTED TO AN EQUIVALENT RECEPTACLE MARKED HOSPITAL ONLY OR HOSPITAL GRADE.

CONTROLLED

NOTES:

1. CORDAGE: SJTW, 14AWG / 3C, UNSHIELDED, NA COLOR CODE, TEMP. RATING: 105°C, RATING: 125V 15A, JACKET COLOR: BLACK
2. PLUG: NEMA 5-15P HOSPITAL GRADE (CLEAR)
3. CONNECTOR: LOCKING IEC 60320 C13 (BLACK)
4. APPROVALS: UL, cUL
5. ROHS COMPLIANT
6. LOCKING CONNECTOR RATED UP TO MAXIMUM 35LBS.
7. CAUTION LABEL

Dim range (mm)	Tolerance +/- (mm)	Qualtek Electronics Corp. PPC DIVISION		
0-1	0.15	Part Number: 533013-01		
1-6	0.20	Description: HOSPITAL GRADE LOCKING POWER CORD		
6-18	0.30	UNIT: in		
18-50	0.50	Drawn / Date	Checked / Date	Approved / Date
50-120	0.70	R. Nuti 04-12-24	04-12-24	LY / 04-12-24
120-250	0.90			
250-500	1.20			