

THESE DRAWINGS ARE THE PROPERTY OF QUALTEK ELECTRONICS AND NOT TO BE REPRODUCED FOR OR COMMUNICATED TO A THIRD PARTY WITHOUT THE EXPRESS WRITTEN PERMISSION OF AN OFFICER OF QUALTEK ELECTRONICS.

REVISION			
REV.	DESCRIPTION	DATE	APPROVED

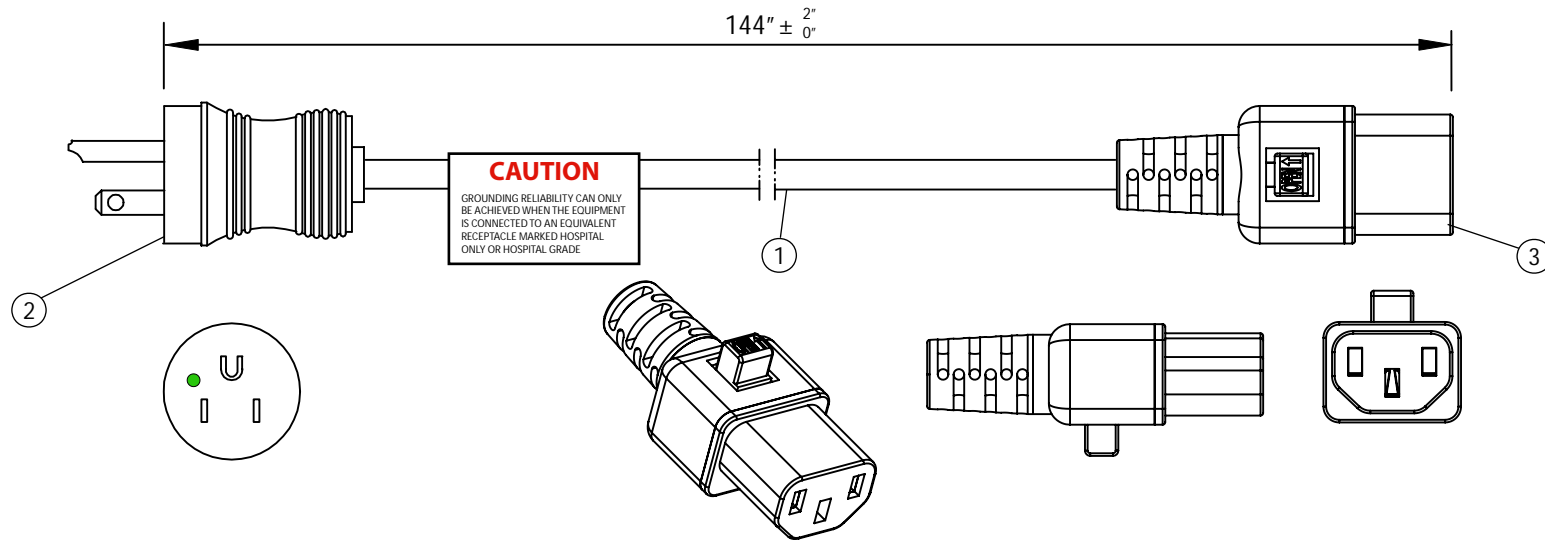

**CAUTION**  
 GROUNDING RELIABILITY CAN ONLY BE ACHIEVED WHEN THE EQUIPMENT IS CONNECTED TO AN EQUIVALENT RECEPTACLE MARKED HOSPITAL ONLY OR HOSPITAL GRADE.

**CONTROLLED**

NOTES:

1. CORDAGE: SJTW, 14AWG / 3C, UNSHIELDED, NA COLOR CODE, TEMP. RATING: 105°C, RATING: 125V 15A, JACKET COLOR: BLACK
2. PLUG: NEMA 5-15P HOSPITAL GRADE (CLEAR)
3. CONNECTOR: LOCKING IEC 60320 C13 (BLACK)
4. APPROVALS: UL, cUL
5. ROHS COMPLIANT
6. LOCKING CONNECTOR RATED UP TO MAXIMUM 35LBS.
7. CAUTION LABEL

Dim range (mm)		Tolerance +/- (mm)		Qualtek Electronics Corp. PPC DIVISION		
0-1	0.15	Part Number: 533015-01		RoHS Compliant		
1-6	0.20	Description: HOSPITAL GRADE LOCKING POWER CORD				
6-18	0.30	UNIT: in				
18-50	0.50	Drawn / Date	Checked / Date	Approved / Date		
50-120	0.70	R. Nuti 04-12-24	04-12-24	LY / 04-12-24		
120-250	0.90					
250-500	1.20					